

Cabinet Handles

Cabinet Handles

Product guide

Stefano Orlati Handles







	Page
Information	8.2
Bow Handles	8.3
Profile Handles	8.12
Provincial Handles	8.16
Recessed Handles	8.19
Square Handles	8.20
Stainless Steel Handles	8.36
Knobs	8.38











Stefano Orlati Handles

Information

Colour Finish Guide

Please note: Colour finish guide is an indicative only - actual finish may vary

AB		Antique Bronze
ABS		Aluminium Brushed Satin
AC		Antique Copper
BLKN		Black Nickel
BN		Brushed Nickel
BSAT		Brushed Satin Antique Tin
BSBN		Brushed Satin Black Nickel
CH		Chrome
CL		Clear Glass
FS		Foggy Silver
MB		Matt Black

MBN		Matt Brushed Nickel
MC		Matt Chrome
P		Pewter
S		Silver
SN		Satin Nickel
SS		Stainless Steel
T		Tungsten
TG		Titanium Grey
WH		White
WHC		White Cracked Finish

Order Guide

All handles & knobs are supplied with a set of screws to suit. When ordering handles or knobs please use the following code string-

	Handle Code	Centre Size	Finish
Example	1037	128mm	BN

Guide To Handle Dimensions

Length: Overall length of the handle(mm)

Centre: Screw hole to screw hole(mm)

Height: Height/Projection of handle(mm)

Width: Width of handle face(mm)

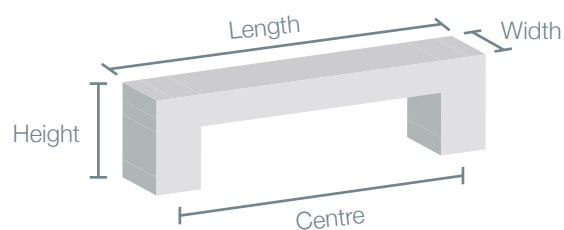

Stefano Orlati Handles

Bow Handles

	Centre (mm)	Length (mm)	Height (mm)	Width (mm)	Item number	Finish
1037   25 Pcs	128	158	29	10	SO-1037-128 →	BN
	128	158	29	10	SO-1037-128 →	CH
	128	158	29	10	SO-1037-128 →	MC
112   10 Pcs	128	170	27	24	SO-112-128 →	BN
	128	170	27	24	SO-112-128 →	MC
114   10 Pcs	160	185	27	24	SO-114-160 →	BN
	160	185	27	24	SO-114-160 →	MC



Stefano Orlati Handles

Bow Handles

	Centre (mm)	Length (mm)	Height (mm)	Width (mm)	Item number	Finish
122  10 Pcs	160	180	26	18	SO-122-160 →	BN
	160	180	26	18	SO-122-160 →	MC
2050  10 Pcs	128	162	30	16	SO-2050-128 →	BN
2051  10 Pcs	128	160	31	16	SO-2051-128 →	BN
	128	160	31	16	SO-2051-128 →	MC
2053  20 Pcs	128	158	30	17	SO-2053-128 →	BN
	128	158	30	17	SO-2053-128 →	MC



Stefano Orlati Handles

Bow Handles

	Centre (mm)	Length (mm)	Height (mm)	Width (mm)	Item number	Finish
2060  <p>50 Pcs (SO-2060-96)</p> <p>25 Pcs (SO-2060-128)</p>	96	115	28	10	SO-2060-96 →	BN
	128	154	30	10	SO-2060-128 →	BN
	96	115	28	10	SO-2060-96 →	MC
	128	154	30	10	SO-2060-128 →	MC
211XL  <p>15 Pcs</p>	224	270	31	14	SO-211XL-224 →	BN
2188  <p>25 Pcs</p>	96	121	29	20	SO-2188-96 →	BN
	96	121	29	20	SO-2188-96 →	MC



Stefano Orlati Handles

Bow Handles

	Centre (mm)	Length (mm)	Height (mm)	Width (mm)	Item number	Finish
3047  50 Pcs (SO-3047-128) 25 Pcs (SO-3047-160)	128	200	27	12	SO-3047-128 →	BN
	160	240	27	12	SO-3047-160 →	BN
	128	200	27	12	SO-3047-128 →	MC
	160	240	27	12	SO-3047-160 →	MC
3062  25 Pcs	160	222	28	26	SO-3062-160 →	BN
	160	222	28	26	SO-3062-160 →	MC
311  50 Pcs	128	165	31	16	SO-311-128 →	BN
	128	165	31	16	SO-311-128 →	MC

Stefano Orlati Handles

Bow Handles

	Centre (mm)	Length (mm)	Height (mm)	Width (mm)	Item number	Finish
3130 	128	147	30	18	SO-3130-128 →	BN
	192	222	30	18	SO-3130-192 →	BN
	256	275	30	18	SO-3130-256 →	BN
	416	430	30	18	SO-3130-416 →	BN
	128	147	30	18	SO-3130-128 →	CH
	192	222	30	18	SO-3130-192 →	CH
	256	275	30	18	SO-3130-256 →	CH
	416	430	30	18	SO-3130-416 →	CH
	128	147	30	18	SO-3130-128 →	MB
	192	222	30	18	SO-3130-192 →	MB
	256	275	30	18	SO-3130-256 →	MB
	416	430	30	18	SO-3130-416 →	MB
	128	147	30	18	SO-3130-128 →	WH
	192	222	30	18	SO-3130-192 →	WH
	256	275	30	18	SO-3130-256 →	WH
	416	430	30	18	SO-3130-416 →	WH
325 	128	168	29	12	SO-325-128 →	CH
	160	200	29	12	SO-325-160 →	CH
	224	264	30	12	SO-325-224 →	CH
	320	360	30	12	SO-325-320 →	CH
	128	168	29	12	SO-325-128 →	SN
	160	200	29	12	SO-325-160 →	SN
	224	264	30	12	SO-325-224 →	SN
320	360	30	12	SO-325-320 →	SN	

 50 Pcs

 25 Pcs (SO-325-128, SO-325-160)

 125 Pcs (SO-325-224, SO-325-320)



Stefano Orlati Handles

Bow Handles

	Centre (mm)	Length (mm)	Height (mm)	Width (mm)	Item number	Finish
3319 	96	140	22	15	SO-3319-96 →	BN
	192	250	22	15	SO-3319-192 →	BN
	96	140	22	15	SO-3319-96 →	MC
	192	250	22	15	SO-3319-192 →	MC
 40 Pcs (SO-3319-192)  50 Pcs (SO-3319-96)						
3380 	128	151	28	25	SO-3380-128 →	BN
	160	189	28	25	SO-3380-160 →	BN
	224	260	33	25	SO-3380-224 →	BN
	320	358	33	25	SO-3380-320 →	BN
	416	463	38	25	SO-3380-416 →	BN
	128	151	28	25	SO-3380-128 →	T
	160	189	28	25	SO-3380-160 →	T
	224	260	33	25	SO-3380-224 →	T
	320	358	33	25	SO-3380-320 →	T
	416	463	38	25	SO-3380-416 →	T
 50 Pcs (SO-3380-128, 125 Pcs)						
6329 	128	167	26	22	SO-6329-128 →	MBN
	192	231	26	22	SO-6329-192 →	MBN
	256	295	26	22	SO-6329-256 →	MBN
	320	359	27	22	SO-6329-320 →	MBN
 25 Pcs (SO-6239-256, 20 Pcs)						

Stefano Orlati Handles

Bow Handles

	Centre (mm)	Length (mm)	Height (mm)	Width (mm)	Item number	Finish
688  25 Pcs	96	124	12	26	SO-688-96	CH/SN
7025  10 Pcs	128	138	25	20	SO-7025-128	BN
	160	170	28	20	SO-7025-160	BN
	224	234	28	20	SO-7025-224	BN
	320	330	28	20	SO-7025-320	BN
	128	138	25	20	SO-7025-128	MC
	160	170	28	20	SO-7025-160	MC
	224	234	28	20	SO-7025-224	MC
	320	330	28	20	SO-7025-320	MC
9238  25 Pcs	96	118	25	12	SO-9238-96	SN





Stefano Orlati Handles

Bow Handles

	Centre (mm)	Length (mm)	Height (mm)	Width (mm)	Item number	Finish
9718 	96	141	30	9	SO-9718-96 →	BN
	128	200	30	12	SO-9718-128 →	BN
	96	141	30	9	SO-9718-96 →	MC
	128	200	30	12	SO-9718-128 →	MC
 40 Pcs (SO-9718-96)  20 Pcs (SO-9718-128)						
9908 	96	105	30	13	SO-9908-96 →	BN
	128	147	30	14	SO-9908-128 →	BN
	96	105	30	13	SO-9908-96 →	CH
	128	147	30	14	SO-9908-128 →	CH
	96	105	30	13	SO-9908-96 →	MC
	128	147	30	14	SO-9908-128 →	MC
 40 Pcs (SO-9908-96)  20 Pcs (SO-9908-128)						
9910 	96	114	21	10	SO-9910-96 →	BN
	128	150	27	12	SO-9910-128 →	BN
	96	114	21	10	SO-9910-96 →	MC
	128	150	27	12	SO-9910-128 →	MC
 25 Pcs (SO-9910-96)  20 Pcs (SO-9910-128)						
ARC 	128	153	31	10	SO-ARC-128 →	BN
	160	190	31	10	SO-ARC-160 →	BN
	224	263	31	10	SO-ARC-224 →	BN
	288	336	31	10	SO-ARC-288 →	BN
 10 Pcs (SO-ARC-288)  25 Pcs (SO-ARC-128, SO-ARC-224)  40 Pcs (SO-ARC-160)						

Stefano Orlati Handles

Bow Handles

	Centre (mm)	Length (mm)	Height (mm)	Width (mm)	Item number	Finish
C 	128	148	26	10	SO-C-128 →	BN
	160	180	26	10	SO-C-160 →	BN
	192	212	26	10	SO-C-192 →	BN
	128	148	26	10	SO-C-128 →	FS
	160	180	26	10	SO-C-160 →	FS
	192	212	26	10	SO-C-192 →	FS
	128	148	26	10	SO-C-128 →	MB
	160	180	26	10	SO-C-160 →	MB
	192	212	26	10	SO-C-192 →	MB
 125 Pcs						
TSB 	96	111	29	10	SO-TSB-96 →	BLKN
	128	150	30	10	SO-TSB-128 →	BLKN
	96	111	29	10	SO-TSB-96 →	BN
	128	150	30	10	SO-TSB-128 →	BN
	96	111	29	10	SO-TSB-96 →	CH
	128	150	30	10	SO-TSB-128 →	CH
	96	111	29	10	SO-TSB-96 →	MB
	96	111	29	10	SO-TSB-96 →	MC
	128	150	30	10	SO-TSB-128 →	MC
	96	111	29	10	SO-TSB-96 →	SN
	128	150	30	10	SO-TSB-128 →	SN
	 25 Pcs (SO-TSB-96)  50 Pcs (SO-TSB-128)					





Stefano Orlati Handles

Bow Handles

410



Centre (mm)	Length (mm)	Height (mm)	Width (mm)	Item number	Finish
64	79	24	10	608.8J20.064.007	PC
64	79	24	10	608.8J20.064.003	BN
64	79	24	10	608.8J20.064.012	BLN
96	112	28	10	608.8J20.096.007	PC
96	112	28	10	608.8J20.096.003	BN
96	112	28	10	608.8J20.096.008	SC
96	112	28	10	608.8J20.096.013	MC
96	112	28	10	608.8J20.096.012	BLN
96	112	28	10	608.8J20.096.004	MB
128	144	35	10	608.8J20.128.007	PC
128	144	35	10	608.8J20.128.003	BN
128	144	35	10	608.8J20.128.008	SC
128	144	35	10	608.8J20.128.012	BLN
128	144	35	10	608.8J20.128.013	MC
224	288	37	10	608.8J20.224.007	PC
224	288	37	10	608.8J20.224.005	BN
224	288	37	10	608.8J20.224.008	SC
224	288	37	10	608.8J20.224.003	BLN

-  50 / 500 Pcs (064)
-  50 / 500 Pcs (096)
-  25 / 250 Pcs (128)
-  25 / 250 Pcs (224)

Made of aluminium

Stefano Orlati Handles

Bow Handles

	Centre (mm)	Length (mm)	Height (mm)	Width (mm)	Item number	Finish
7235 	128	163	27	16	608.8O19.128.003	BN
	160	204	26	16	608.8O19.160.003	BN
	320	372	26	16	608.8O19.320.003	BN
 25 Pcs	Made of zinc					
7236 	128	248	25	16	608.8O20.128.003	BN
	160	272	25	16	608.8O20.160.003	BN
	320	410	25	16	608.8O20.320.003	BN
 25 Pcs	Made of zinc					
7238 	128	174	26	17	608.8O21.128.003	BN
	160	210	27	18	608.8O21.160.003	BN
	320	376	28	20	608.8O21.320.003	BN
 25 Pcs	Made of zinc					
779 		35	23	16	608.8F18.035.008	SC
	128	138	27	21	608.8F18.128.008	SC
	160	170	27	21	608.8F18.160.008	SC
 25 Pcs	Made of zinc					

Stefano Orlati Handles

Bow Handles

	Centre (mm)	Length (mm)	Height (mm)	Width (mm)	Item number	Finish
3409	32	50	25	10	608.8C18.032.003	BN
	128	160	25	10	608.8C18.128.003	BN
	288	300	25	10	608.8C18.288.003	BN
						
<p>  50 Pcs (032.003)  25 Pcs (128.003 - 288.003) </p> <p>Made of aluminium</p>						
7130	20	40	25	35	608.8C17.020.003	BN
	80	100	25	35	608.8C17.080.003	BN
	160	180	25	35	608.8C17.160.003	BN
	260	280	25	35	608.8C17.260.003	BN
						
<p>  50 Pcs (030.003)  25 Pcs (080.003 - 160.003, 260.003) </p> <p>Made of steel</p>						

Stefano Orlati Handles

Bow Handles

748



 25 Pcs

Made of zinc

7106



 25 Pcs

Made of zinc

Centre (mm)	Length (mm)	Height (mm)	Width (mm)	Item number	Finish
96	134	28	10	608.8D12.096.007	PC
96	134	28	10	608.8D12.096.003	BN
128	166	28	10	608.8O12.128.007	PC
128	166	28	10	608.8O12.128.003	BN
96	110	25	12	608.8C16.096.003	BN
128	142	25	12	608.8C16.128.003	BN
160	174	25	12	608.8C16.160.003	BN
256	270	25	12	608.8C16.256.003	BN
320	334	25	12	608.8C16.320.003	BN

Stefano Orlati Handles

Profile Handles

	Length (mm)	Height (mm)	Width (mm)	Item number	Finish
<p>AK0891</p>   <p>Side Profile</p> <p>3 Metres</p>	3000	35	18	SO-AK0891 →	FS
<p>AK0891B</p>   <p>Side Profile</p> <p>3 Metres</p>	3000	35	18	SO-AK0891B →	FS

Stefano Orlati Handles

Profile Handles

	Centre (mm)	Length (mm)	Height (mm)	Width (mm)	Item number	Finish
AK0894		3000	30	16	SO-AK0894 →	FS
  Side Profile						
 3 Metres						
CAPRI-C		3600	71.8	26	SO-CAPRI-C →	FS
  Side Profile						
 3.6 Metres (Please order your Capri end caps and brackets separately.)						
					→ End Cap CAPRI-C-EC	
					→ BRACKET CAPRI-B	





Stefano Orlati Handles

Profile Handles

	Centre (mm)	Length (mm)	Height (mm)	Width (mm)	Item number	Finish
CAPRI-J		3600	57	26	SO-CAPRI-J →	FS
		3600	57	26	SO-CAPRI-J →	TG
  Side Profile  3.6 Metres (Please order your Capri end caps and brackets separately.)					End Cap CAPRI-J-EC	
					BRACKET CAPRI-B	
PESARO PULL		200	18	36	SO-PP-200 →	ABS
					2 screw holes - 40 mm from edge	
		400	18	36	SO-PP-400 →	ABS
					3 screw holes - 100 mm between each hole & edge	
		600	18	36	SO-PP-600 →	ABS
					4 screw holes - 120 mm between each hole & edge	
	1250	18	36	SO-PP-1250 →	ABS	
					Without holes drilled	
					· Mounts on top of panel edge	
  Side Profile 50 Pcs (except SO-PP-200, 100 Pcs)						

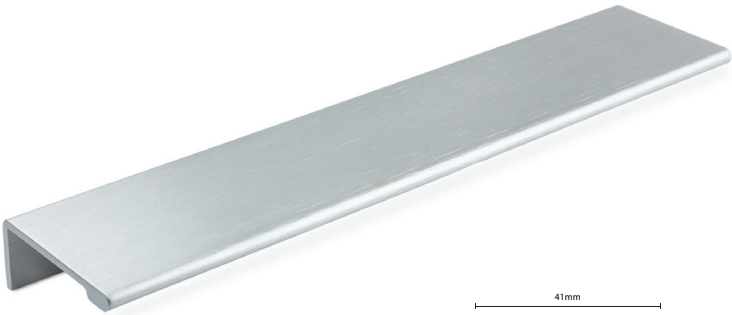
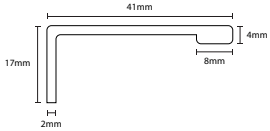
Stefano Orlati Handles

Profile Handles

	Centre (mm)	Length (mm)	Height (mm)	Width (mm)	Item number	Finish
R156   Side Profile	64	90	17	41	SO-R156-64 →	ABS
	160	190	17	41	SO-R156-160 →	ABS
	64	90	17	41	SO-R156-64 →	FS
	160	190	17	41	SO-R156-160 →	FS
· Mounts on top of panel edge						
 50 Pcs						
7021 	16	29	25	8	608.8A18.016.003	BN
	96	109	25	8	608.8A18.096.003	BN
	128	141	25	8	608.8A18.128.003	BN
	160	173	25	8	608.8A18.160.003	BN
	256	269	25	8	608.8A18.256.003	BN
	320	333	25	8	608.8A18.320.003	BN
 25 Pcs  50 Pcs (016.003)	Made of zinc					

Stefano Orlati Handles

Profile Handles

548

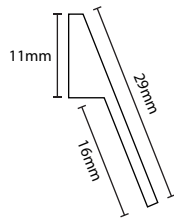

Side Profile

Centre (mm)	Length (mm)	Height (mm)	Width (mm)	Item number	Finish
128	170	26	17	SO-548-128 →	ABS
192	235	26	17	SO-548-192 →	ABS
320	362	26	17	SO-548-320 →	ABS
544	588	26	17	SO-548-544 →	ABS
608	650	26	17	SO-548-608 →	ABS
736	775	26	17	SO-548-736 →	ABS
128	170	26	17	SO-548-128 →	MB
192	235	26	17	SO-548-192 →	MB
320	362	26	17	SO-548-320 →	MB
544	588	26	17	SO-548-544 →	MB
608	650	26	17	SO-548-608 →	MB
736	775	26	17	SO-548-736 →	MB





 25 Pcs (SO-548-608, SO-548-736)

 50 Pcs (SO-548-128, SO-548-192, SO-548-544)

 100 Pcs (SO-548-320)

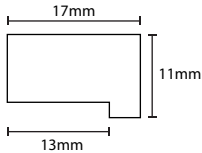

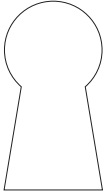
Stefano Orlati Handles

Profile Handles

	Centre (mm)	Length (mm)	Height (mm)	Width (mm)	Item number	Finish
274   Side Profile	96	120	17	11	SO-274-96 →	CH
	96	120	17	11	SO-274-96 →	FS
	128	150	17	11	SO-274-128 →	FS
	192	245	17	11	SO-274-192 →	FS
	288	330	17	11	SO-274-288 →	FS
	576	628	17	11	SO-274-576 →	FS
	864	914	17	11	SO-274-864 →	FS
	 50 Pcs (except SO-274-288-FS, 100 Pcs)					
276   Side Profile	96	120	20	10	SO-276-96 →	CH
	64	98	20	10	SO-276-64 →	FS
	96	120	20	10	SO-276-96 →	FS
	128	150	20	10	SO-276-128 →	FS
	192	245	20	10	SO-276-192 →	FS
	288	330	20	10	SO-276-288 →	FS
	 50 Pcs					





Stefano Orlati Handles

Provincial Handles

	Centre (mm)	Length (mm)	Height (mm)	Width (mm)	Item number	Finish
1186  50 Pcs	96	132	29	14	SO-1186-96 →	BSAT
	160	204	29	16	SO-1186-160 →	BSAT
	96	132	29	14	SO-1186-96 →	BSBN
	160	204	29	16	SO-1186-160 →	BSBN
	Complementary knob 1186K page → 8.39					
1208  50 Pcs	96	135	31	34	SO-1208-96 →	BSAT
	96	135	31	34	SO-1208-96 →	BSBN
	Complementary knob 1186K page → 8.39					
3440  25 Pcs (SO-3440-320, 50 Pcs)	128	150	33	18	SO-3440-128 →	BN
	160	182	33	18	SO-3440-160 →	BN
	224	246	33	18	SO-3440-224 →	BN
	320	342	33	18	SO-3440-320 →	BN
	128	150	33	18	SO-3440-128 →	BSBN
	160	182	33	18	SO-3440-160 →	BSBN
	224	246	33	18	SO-3440-224 →	BSBN
	320	342	33	18	SO-3440-320 →	BSBN
	Complementary knob 3440 page → 8.41					

Stefano Orlati Handles

Provincial Handles

	Centre (mm)	Length (mm)	Height (mm)	Width (mm)	Item number	Finish
8391  30 Pcs	160	180	32	40	SO-8391-160 →	P
Complementary knob 3801 page → 8.41 Complementary knob 8393 page → 8.42						
8392  50 Pcs	128	188	28	21	SO-8392-128 →	P
Complementary knob 3801 page → 8.41 Complementary knob 8393 page → 8.42						
8407  50 Pcs	64	90	23	34	SO-8407-64 →	AB
	64	90	23	34	SO-8407-64 →	BN
	64	90	23	34	SO-8407-64 →	CH
Complementary knob 8741 page → 8.43						
8658  50 Pcs	96	132	25	16	SO-8658-96 →	AB
	96	132	25	16	SO-8658-96 →	BN
	96	132	25	16	SO-8658-96 →	CH
Complementary knob 8741 page → 8.42						

Stefano Orlati Handles

Provincial Handles

	Centre (mm)	Length (mm)	Height (mm)	Width (mm)	Item number	Finish
C15	128	150	40	23	SO-C15-128 →	WHC/P
 <p>Complementary knobs C10 and C14 page → 8.44</p>						

 20 Pcs

Stefano Orlati Handles

Recessed Handles

	Centre (mm)	Length (mm)	Height (mm)	Width (mm)	Item number	Finish
1159  50 Pcs	35		7	40	SO-1159 →	BN
709  25 Pcs	128	138	13	30	SO-709-128 →	S
	· Suit minimum 16mm board · Recess depth 10mm					
AHS403  25 Pcs (SO-AHS403-160) 40 Pcs (SO-AHS403-128)	128	145	16	42	SO-AHS403-128 →	ABS
	160	172	16	42	SO-AHS403-160 →	ABS
	128	145	16	42	SO-AHS403-128 →	FS
	160	172	16	42	SO-AHS403-160 →	FS
	· Suit minimum 16mm board · Recess depth 14mm · ABS in this range is a dark version of the aluminium brushed satin finish.					
MH20  7 Pcs	127	170	18	40	SO-MH20-127 →	S
	226	330	18	40	SO-MH20-226 →	S
	· Suit minimum 18mm board · Recess depth 15mm					

Stefano Orlati Handles

Recessed Handles

	Centre (mm)	Length (mm)	Height (mm)	Width (mm)	Item number	Finish
7057	128	138	30	16	608.8C18.128.910	AA
	128	138	30	16	608.8C18.128.010*	MB
	128	138	30	16	608.8C18.128.011*	MW

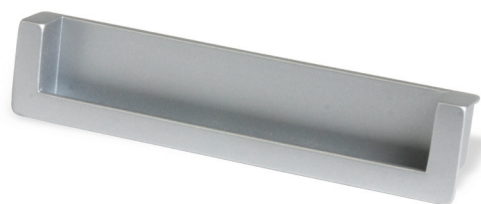

* Available upon special request

 25 Pcs

Made of zinc

Stefano Orlati Handles

Square Handles

1092



Centre (mm)	Length (mm)	Height (mm)	Width (mm)	Item number	Finish
96	102	27	11	SO-1092-96 →	BN
128	134	27	11	SO-1092-128 →	BN
160	166	27	11	SO-1092-160 →	BN
224	230	27	11	SO-1092-224 →	BN
288	294	27	11	SO-1092-288 →	BN
320	326	27	11	SO-1092-320 →	BN
96	102	27	11	SO-1092-96 →	CH
128	134	27	11	SO-1092-128 →	CH
160	166	27	11	SO-1092-160 →	CH
224	230	27	11	SO-1092-224 →	CH
288	294	27	11	SO-1092-288 →	CH
320	326	27	11	SO-1092-320 →	CH
96	102	27	11	SO-1092-96 →	MC
128	134	27	11	SO-1092-128 →	MC
160	166	27	11	SO-1092-160 →	MC
224	230	27	11	SO-1092-224 →	MC
288	294	27	11	SO-1092-288 →	MC
320	326	27	11	SO-1092-320 →	MC

 10 Pcs (SO-1092-224, SO-1092-288, SO-1092-320)

 20 Pcs (SO-1092-128, SO-1092-160)

 25 Pcs (SO-1092-96)

Stefano Orlati Handles

Square Handles

	Centre (mm)	Length (mm)	Height (mm)	Width (mm)	Item number	Finish
113 	160	179	26	27	SO-113-160 →	BN
	160	179	26	27	SO-113-160 →	MC
 10 Pcs						
116 	128	159	29	15	SO-116-128 →	BN
	160	190	29	15	SO-116-160 →	BN
	128	159	29	15	SO-116-128 →	MC
	160	190	29	15	SO-116-160 →	MC
 10 Pcs						
1745 	128	137	28	21	SO-1745-128 →	BN
	192	201	28	21	SO-1745-192 →	BN
	256	265	28	21	SO-1745-256 →	BN
	128	137	28	21	SO-1745-128 →	MC
	192	201	28	21	SO-1745-192 →	MC
	256	265	28	21	SO-1745-256 →	MC
 25 Pcs						

Stefano Orlati Handles

Square Handles

1759

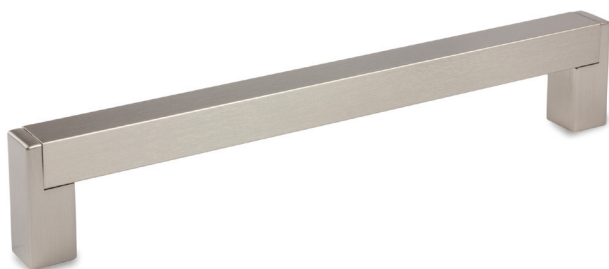

Centre (mm)	Length (mm)	Height (mm)	Width (mm)	Item number	Finish
96	115	38	15	SO-1759-96 →	BN
128	148	38	15	SO-1759-128 →	BN
192	210	38	15	SO-1759-192 →	BN
224	245	38	15	SO-1759-224 →	BN
320	339	38	15	SO-1759-320 →	BN
480	499	38	15	SO-1759-480 →	BN
544	563	38	15	SO-1759-544 →	BN
736	755	38	15	SO-1759-736 →	BN
96	115	38	15	SO-1759-96 →	CH
128	148	38	15	SO-1759-128 →	CH
192	210	38	15	SO-1759-192 →	CH
224	245	38	15	SO-1759-224 →	CH
320	339	38	15	SO-1759-320 →	CH
480	499	38	15	SO-1759-480 →	CH
544	563	38	15	SO-1759-544 →	CH
736	755	38	15	SO-1759-736 →	CH
96	115	38	15	SO-1759-96 →	FS
128	148	38	15	SO-1759-128 →	FS
192	210	38	15	SO-1759-192 →	FS
224	245	38	15	SO-1759-224 →	FS
320	339	38	15	SO-1759-320 →	FS
480	499	38	15	SO-1759-480 →	FS
544	563	38	15	SO-1759-544 →	FS
736	755	38	15	SO-1759-736 →	FS

50 Pcs (SO-1759-128, SO-1759-480, SO-1759-544, SO-1759-736, SO-1759-96)

25 Pcs (SO-1759-192, SO-1759-224)

100 Pcs (SO-1759-320)

Stefano Orlati Handles



Square Handles

	Centre (mm)	Length (mm)	Height (mm)	Width (mm)	Item number	Finish
216	256	295	28	12	SO-216-256 →	FS
	320	370	28	12	SO-216-320 →	FS
255	128	145	30	11.5	SO-255-128 →	BN
	192	210	30	11.5	SO-255-192 →	BN
	544	560	30	11.5	SO-255-544 →	BN
	608	625	30	11.5	SO-255-608 →	BN



 100 Pcs





 50 Pcs (SO-255-128, SO-255-192)
 100 Pcs (SO-255-544, SO-255-608)

Stefano Orlati Handles

Square Handles

	Centre (mm)	Length (mm)	Height (mm)	Width (mm)	Item number	Finish
7011	96	102	26	12	608.8R16.096.007	PC
	128	134	26	12	608.8R16.128.007	PC
	160	166	26	12	608.8R16.160.007	PC
	256	262	26	12	608.8R16.256.007	PC
	32	41	26	12	608.8R16.032.003	BN
	96	102	26	12	608.8R16.096.003	BN
	128	134	26	12	608.8R16.128.003	BN
	160	166	26	12	608.8R16.160.003	BN
	256	262	26	12	608.8R16.256.003	BN
	320	326	26	12	608.8R16.320.003	BN
	448	454	26	12	608.8R16.448.003	BN
7202	96	111	28	12	608.8E18.096.003	BN
	128	144	28	12	608.8E18.128.003	BN
	160	176	28	12	608.8E18.160.003	BN
	256	272	28	12	608.8E18.256.003	BN
	320	337	28	12	608.8E18.320.003	BN



 25 Pcs (128.006, 160.003, 256.003, 320.003, 448.003)
 50 Pcs (032.003, 096.007, 096.003) Made of aluminium



 25 Pcs Made of zinc

Stefano Orlati Handles

Square Handles



Centre (mm)	Length (mm)	Height (mm)	Width (mm)	Item number	Finish
96	109	36	16	SO-288-96 →	BN
128	141	36	16	SO-288-128 →	BN
160	173	36	16	SO-288-160 →	BN
224	237	36	16	SO-288-224 →	BN
288	301	36	16	SO-288-288 →	BN
448	461	36	16	SO-288-448 →	BN
544	557	36	16	SO-288-544 →	BN
650	663	36	16	SO-288-650 →	BN
96	109	36	16	SO-288-96 →	CH
128	141	36	16	SO-288-128 →	CH
160	173	36	16	SO-288-160 →	CH
224	237	36	16	SO-288-224 →	CH
288	301	36	16	SO-288-288 →	CH
448	461	36	16	SO-288-448 →	CH
544	557	36	16	SO-288-544 →	CH
650	663	36	16	SO-288-650 →	CH
<i>Product information continues, next page</i>					→



 40 Pcs (Centre lengths 16 and 160mm)

 50 Pcs (Centre lengths 128, 448, 544, 650 and 96mm)

 100 Pcs (Centre lengths 224 and 288mm)

Stefano Orlati Handles

Square Handles

	Centre (mm)	Length (mm)	Height (mm)	Width (mm)	Item number	Finish
 <p> 40 Pcs (Centre lengths 16 and 160mm) 50 Pcs (Centre lengths 128, 448, 544, 650, 736 and 96mm) 100 Pcs (Centre lengths 224 and 288mm) </p>	96	109	36	16	SO-288-96 →	FS
	128	141	36	16	SO-288-128 →	FS
	160	173	36	16	SO-288-160 →	FS
	224	237	36	16	SO-288-224 →	FS
	288	301	36	16	SO-288-288 →	FS
	448	461	36	16	SO-288-448 →	FS
	544	557	36	16	SO-288-544 →	FS
	650	663	36	16	SO-288-650 →	FS
	736	749	36	16	SO-288-736 →	FS
Complementary knob 288 page → 8.39						
298  <p> 25 Pcs (SO-298-128) 40 Pcs (SO-298-64) 100 Pcs (SO-298-256) </p>	64	78	32	15	SO-298-64 →	BN
	128	142	32	15	SO-298-128 →	BN
	256	270	32	15	SO-298-256 →	BN
	64	78	32	15	SO-298-64 →	CH
	128	142	32	15	SO-298-128 →	CH
	256	270	32	15	SO-298-256 →	CH
	64	78	32	15	SO-298-64 →	MC
	128	142	32	15	SO-298-128 →	MC
	256	270	32	15	SO-298-256 →	MC

Stefano Orlati Handles

Square Handles

	Centre (mm)	Length (mm)	Height (mm)	Width (mm)	Item number	Finish
305 	128	145	25	12	SO-305-128 →	BN
	160	177	25	12	SO-305-160 →	BN
	224	241	27	12	SO-305-224 →	BN
	320	337	27	12	SO-305-320 →	BN
	128	145	25	12	SO-305-128 →	MC
	160	177	25	12	SO-305-160 →	MC
	224	241	27	12	SO-305-224 →	MC
	320	337	27	12	SO-305-320 →	MC
<ul style="list-style-type: none">  25 Pcs (SO-305-128, SO-305-160)  50 Pcs (SO-305-224)  125 Pcs (SO-305-320) 						
3061 	128	158	25	20	SO-3061-128 →	BN
	192	226	27	24	SO-3061-192 →	BN
	128	158	25	20	SO-3061-128 →	MC
	192	226	27	24	SO-3061-192 →	MC
<ul style="list-style-type: none">  8 Pcs (SO-3061-128)  10 Pcs (SO-3061-192) 						

Stefano Orlati Handles

Square Handles

3064



-  15 Pcs (SO-3064-160, SO-3064-240 and SO-3064-320)
-  20 Pcs (SO-3064-128, SO-3064-192)
-  25 Pcs (SO-3064-96)

508



-  20 Pcs

Centre (mm)	Length (mm)	Height (mm)	Width (mm)	Item number	Finish
96	121	27	8	SO-3064-96 →	BN
128	157	27	8	SO-3064-128 →	BN
160	192	27	8	SO-3064-160 →	BN
192	224	27	8	SO-3064-192 →	BN
240	273	27	8	SO-3064-240 →	BN
320	355	27	8	SO-3064-320 →	BN
96	121	27	8	SO-3064-96 →	MC
128	157	27	8	SO-3064-128 →	MC
160	192	27	8	SO-3064-160 →	MC
192	224	27	8	SO-3064-192 →	MC
240	273	27	8	SO-3064-240 →	MC
320	355	27	8	SO-3064-320 →	MC
96	127	20	16	SO-508-96 →	SN

Stefano Orlati Handles

Square Handles

6002

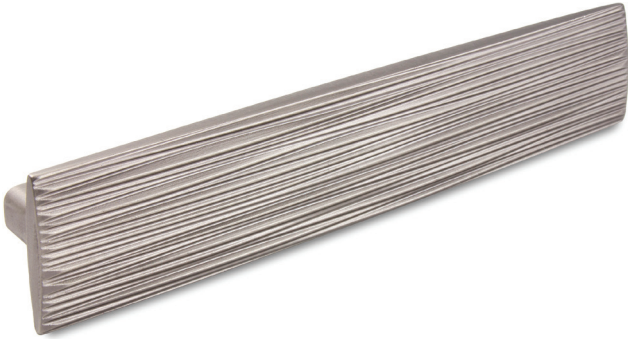

Centre (mm)	Length (mm)	Height (mm)	Width (mm)	Item number	Finish
96	114	31	36	SO-6002-96 →	AB
160	178	31	36	SO-6002-160 →	AB
96	114	31	36	SO-6002-96 →	MC
160	178	31	36	SO-6002-160 →	MC



Complementary handles 6002 page → 8.42

 25 Pcs (except, SO-6002-160, 10 Pcs)

Stefano Orlati Handles



Square Handles

	Centre (mm)	Length (mm)	Height (mm)	Width (mm)	Item number	Finish
6330 	128	142	30	25	SO-6330-128 →	BN
	192	206	30	25	SO-6330-192 →	BN
	256	269	30	25	SO-6330-256 →	BN
	320	334	30	25	SO-6330-320 →	BN
	544	558	30	25	SO-6330-544 →	BN
	128	142	30	25	SO-6330-128 →	FS
	192	206	30	25	SO-6330-192 →	FS
	256	269	30	25	SO-6330-256 →	FS
	320	334	30	25	SO-6330-320 →	FS
	544	558	30	25	SO-6330-544 →	FS
690 	64	83	18	11	SO-690-64 →	CH
	64	83	18	11	SO-690-64 →	MC
809 	96	108	18	12	SO-809-96 →	BN
	160	178	18	12	SO-809-160 →	BN
	256	274	20	12	SO-809-256 →	BN
	96	108	18	12	SO-809-96 →	CH
	160	178	18	12	SO-809-160 →	CH
	256	274	20	12	SO-809-256 →	CH
	96	108	18	12	SO-809-96 →	MC
	160	178	18	12	SO-809-160 →	MC
	256	274	20	12	SO-809-256 →	MC
	Complementary knob 809 page → 8.42					

-  25 Pcs (SO-6330-320, SO-6330-544)
-  30 Pcs (SO-6330-256)
-  50 Pcs (SO-6330-128, SO-6330-192)

 50 Pcs

809

-  25 Pcs (SO-809-160)
-  50 Pcs (SO-809-96, SO-809-256)

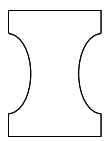

Side Profile



Stefano Orlati Handles

Square Handles



	Centre (mm)	Length (mm)	Height (mm)	Width (mm)	Item number	Finish
8230  25 Pcs (SO-8230-128, SO-8230-192) 100 Pcs (SO-8230-480) 125 Pcs (SO-8230-320)	128	192	30	10	SO-8230-128 →	ABS
	192	256	30	10	SO-8230-192 →	ABS
	320	384	30	10	SO-8230-320 →	ABS
	480	544	30	10	SO-8230-480 →	ABS
843  25 Pcs	128	174	27	26	SO-843-128 →	AC
	192	238	27	26	SO-843-192 →	AC
	128	174	27	26	SO-843-128 →	CH
	192	238	27	26	SO-843-192 →	CH
8645  50 Pcs	160	250	30	7	SO-8645-160 →	ABS
	160	250	30	7	SO-8645-160 →	CH
	160	250	30	7	SO-8645-160 →	FS
8650  50 Pcs	160	250	30	7	SO-8650-160 →	ABS
	160	250	30	7	SO-8650-160 →	CH
	160	250	30	7	SO-8650-160 →	FS

Stefano Orlati Handles

Square Handles

	Centre (mm)	Length (mm)	Height (mm)	Width (mm)	Item number	Finish	
A							
		128	135	30	12	SO-A-128 →	BN
		160	167	30	12	SO-A-160 →	BN
		224	231	30	12	SO-A-224 →	BN
		320	327	30	12	SO-A-320 →	BN
		128	135	30	12	SO-A-128 →	FS
		160	167	30	12	SO-A-160 →	FS
		224	231	30	12	SO-A-224 →	FS
		320	327	30	12	SO-A-320 →	FS
		128	135	30	12	SO-A-128 →	MB
		160	167	30	12	SO-A-160 →	MB
		224	231	30	12	SO-A-224 →	MB
	320	327	30	12	SO-A-320 →	MB	
B							
		128	135	30	16	SO-B-128 →	BN
		160	167	30	16	SO-B-160 →	BN
		224	231	30	16	SO-B-224 →	BN
		320	327	30	16	SO-B-320 →	BN
		128	135	30	16	SO-B-128 →	FS
		160	167	30	16	SO-B-160 →	FS
		224	231	30	16	SO-B-224 →	FS
		320	327	30	16	SO-B-320 →	FS
		128	135	30	16	SO-B-128 →	MB
		160	167	30	16	SO-B-160 →	MB
		224	231	30	16	SO-B-224 →	MB
	320	327	30	16	SO-B-320 →	MB	

-  50 Pcs (SO-A-224 and SO-A-320)
-  100 Pcs (SO-A-160)
-  125 Pcs (SO-A-128)

-  25 Pcs (SO-A-160)
-  50 Pcs (SO-A-224 and SO-A-320)
-  125 Pcs (SO-A-128)

Stefano Orlati Handles

Square Handles

	Centre (mm)	Length (mm)	Height (mm)	Width (mm)	Item number	Finish
D	96	106	37	10	SO-D-96 →	BN
	96	106	37	10	SO-D-96 →	MC
	128	138	37	10	SO-D-128 →	MC
GL01	128	143	30	35	SO-GL01-128 →	CL/CH
	192	207	30	35	SO-GL01-192 →	CL/CH
	256	271	30	35	SO-GL01-256 →	CL/CH
	320	335	30	35	SO-GL01-320 →	CL/CH



 25 Pcs







 10 Pcs (SO-GL01-256)

 12 Pcs (SO-GL01-128)

 15 Pcs (SO-GL01-192 and 320)

Stefano Orlati Handles

Square Handles

	Centre (mm)	Length (mm)	Height (mm)	Width (mm)	Item number	Finish
IN2 	90	108	30	8	SO-IN2-90 →	CH
	 25 Pcs					
MH14 	64	78	29	7	SO-MH14-64 →	BN
	96	110	29	7	SO-MH14-96 →	BN
	128	141	29	7	SO-MH14-128 →	BN
	224	238	29	7	SO-MH14-224 →	BN
	320	333	29	7	SO-MH14-320 →	BN
	64	78	29	7	SO-MH14-64 →	CH
	96	110	29	7	SO-MH14-96 →	CH
	128	141	29	7	SO-MH14-128 →	CH
	224	238	29	7	SO-MH14-224 →	CH
	320	333	29	7	SO-MH14-320 →	CH
	64	78	29	7	SO-MH14-64 →	S
	96	110	29	7	SO-MH14-96 →	S
	128	141	29	7	SO-MH14-128 →	S
	224	238	29	7	SO-MH14-224 →	S
320	333	29	7	SO-MH14-320 →	S	
 20 pcs (SO-MH14-224, SO-MH14-320)  25 pcs (SO-MH14-64, SO-MH14-96, SO-MH14-128)						

Stefano Orlati Handles

Square Handles

	Centre (mm)	Length (mm)	Height (mm)	Width (mm)	Item number	Finish
OK90   25 Pcs	128	149	24	7	SO-OK90-128 →	MC
T905   15 Pcs	128	150	20	40	SO-T905-128 →	AB
	192	214	20	40	SO-T905-192 →	AB
	128	150	20	40	SO-T905-128 →	MC
	192	214	20	40	SO-T905-192 →	MC
	Complementary Knob T905K page → 8.45					
TB   50 Pcs	96	154	28	10	SO-TB-96 →	CH

Stefano Orlati Handles

Square Handles

	Centre (mm)	Length (mm)	Height (mm)	Width (mm)	Item number	Finish
7127 	128	148	29	10	608.8F16.128.003	BN
	160	180	29	10	608.8F16.160.003	BN
	256	276	29	10	608.8F16.256.003	BN
	320	340	29	10	608.8F16.320.003	BN
 25 Pcs Made of zinc						
3163 	98	121	25	8	608.8J18.096.003	BN
	128	161	25	8	608.8J18.128.003	BN
	160	193	25	8	608.8J18.160.003	BN
	192	225	25	8	608.8J18.192.003	BN
	240	273	25	8	608.8J18.240.003	BN
	98	121	25	8	608.8J18.096.010	MB
	128	161	25	8	608.8J18.128.010	MB
	160	193	25	8	608.8J18.160.010	MB
	192	225	25	8	608.8J18.192.010	MB
	240	273	25	8	608.8J18.240.010	MB
 25 Pcs Made of zinc						

Stefano Orlati Handles

Square Handles

800



 25 Pcs (076.008, 50 Pcs)

Made of steel

3447





 25 Pcs

Made of zinc

Centre (mm)	Length (mm)	Height (mm)	Width (mm)	Item number	Finish
76	84	32	8	608.8M24.076.008	SC
96	106	32	9.5	608.8M24.096.007	PC
96	106	32	9.5	608.8M24.096.008	SC
128	138	32	9.5	608.8M24.128.007	PC
128	138	32	9.5	608.8M24.128.008	SC
160	170	32	9.5	608.8M24.160.008	SC
192	202	32	9.5	608.8M24.192.007	PC
192	202	32	9.5	608.8M24.192.008	SC
256	266	32	9.5	608.8M24.256.007	PC
256	266	32	9.5	608.8M24.256.008	SC
128	158	25	20	608.8O18.128.003	BN
160	192	25	22	608.8O18.160.003	BN
192	226	25	25	608.8O18.192.003	BN
160	192	25	22	608.8O18.160.010	MB

Stefano Orlati Handles

Square Handles

	Centre (mm)	Length (mm)	Height (mm)	Width (mm)	Item number	Finish
5012 	96	156	30	12	608.8D10.096.003	BN
	128	188	30	12	608.8D10.128.003	BN
	160	220	30	12	608.8D10.160.003	BN
	256	316	30	12	608.8D10.256.003	BN
	320	380	30	12	608.8D10.320.003	BN
	384	444	30	12	608.8D10.384.003	BN
	448	508	30	12	608.8D10.448.003	BN
	544	604	30	12	608.8D10.544.003	BN
	608	668	30	12	608.8D10.608.003	BN
 25 Pcs Made of aluminium						
7012 	128	158	34	10	608.8D12.128.003	BN
	160	190	34	10	608.8D12.160.003	BN
	256	286	34	10	608.8D12.256.003	BN
	320	350	34	10	608.8D12.320.003	BN
	416	446	34	10	608.8D12.416.003	BN
	544	574	34	10	608.8D12.544.003	BN
	608	638	34	10	608.8D12.608.003	BN
	 25 Pcs Made of stainless steel					

Stefano Orlati Handles

Square Handles

	Centre (mm)	Length (mm)	Height (mm)	Width (mm)	Item number	Finish
7105 	96	102	30	20	608.8R18.096.003	BN
	128	134	30	20	608.8R18.128.003	BN
	160	166	30	20	608.8R18.160.003	BN
	256	262	30	20	608.8R18.256.003	BN
	320	326	30	20	608.8R18.320.003	BN
 25 Pcs Made of zinc						
7120 	128	140	31	15	608.8A16.128.003	BN
	160	172	31	15	608.8A16.160.003	BN
	256	268	31	15	608.8A16.256.003	BN
 25 Pcs Made of zinc						

Stefano Orlati Handles

Stainless Steel Handles

	Centre (mm)	Length (mm)	Height (mm)	Width (mm)	Item number	Finish
6820 	128	136	31	21	SO-6820-128 →	SS
	160	168	31	21	SO-6820-160 →	SS
	224	232	31	21	SO-6820-224 →	SS
	320	328	31	21	SO-6820-320 →	SS
	448	456	31	21	SO-6820-448 →	SS
 20 Pcs (SO-6820-128, SO-6820-160, SO-6820-224)  25 Pcs (SO-6820-320, SO-6820-448)						
8513 	128	150	40	13	SO-8513-128 →	SS
	160	182	40	13	SO-8513-160 →	SS
	192	214	40	13	SO-8513-192 →	SS
	224	246	40	13	SO-8513-224 →	SS
	352	374	40	13	SO-8513-352 →	SS
	554	576	40	13	SO-8513-554 →	SS
	576	598	40	13	SO-8513-576 →	SS
	832	854	40	13	SO-8513-832 →	SS
 25 Pcs (SO-8513-832)  40 Pcs (SO-8513-160, SO-8513-192)  50 Pcs (SO-8513-128, SO-8513-224, SO-8513-352, SO-8513-554)  100 Pcs (SO-8513-576)						
8721 	128	138	33	19	SO-8721-128 →	SS
	160	170	33	19	SO-8721-160 →	SS
	192	202	33	19	SO-8721-192 →	SS
	224	234	33	19	SO-8721-224 →	SS
	320	330	33	19	SO-8721-320 →	SS
	448	458	33	19	SO-8721-448 →	SS
	554	564	33	19	SO-8721-554 →	SS
 20 Pcs						

Stefano Orlati Handles

Stainless Steel Handles

	Centre (mm)	Length (mm)	Height (mm)	Width (mm)	Item number	Finish
909 	128	142	40	14	SO-909-128 →	SS
	160	174	40	14	SO-909-160 →	SS
	224	238	40	14	SO-909-224 →	SS
	320	334	40	14	SO-909-320 →	SS
	480	494	40	14	SO-909-480 →	SS
 25 Pcs (except SO-909-480, 20 Pcs)						
SSD 	128	138	33	10	SO-SSD-128 →	SS
	160	170	33	10	SO-SSD-160 →	SS
	192	202	33	10	SO-SSD-192 →	SS
	288	298	33	10	SO-SSD-288 →	SS
	352	362	33	10	SO-SSD-352 →	SS
	448	458	33	10	SO-SSD-448 →	SS
 25 Pcs (except SO-SSD-352, 10 Pcs and SO-SSD-128, 50 Pcs)						
SSTB 	96	136	34	12	SO-SSTB-96 →	SS
	128	168	34	12	SO-SSTB-128 →	SS
	160	200	34	12	SO-SSTB-160 →	SS
	192	232	34	12	SO-SSTB-192 →	SS
	288	328	34	12	SO-SSTB-288 →	SS
	352	392	34	12	SO-SSTB-352 →	SS
	448	488	34	12	SO-SSTB-448 →	SS
	544	584	34	12	SO-SSTB-544 →	SS
	736	776	34	12	SO-SSTB-736 →	SS
960	1000	34	12	SO-SSTB-960 →	SS	
 25 Pcs						

Stefano Orlati Handles

Knobs

	Centre (mm)	Length (mm)	Height (mm)	Width (mm)	Item number	Finish
1112 	16	25	27	21	SO-1112-16 →	BN
	16	25	27	21	SO-1112-16 →	CH
	16	25	27	21	SO-1112-16 →	MC
 100 Pcs						
1160 	K		26	17	SO-1160S-K →	BN
	K		28	25	SO-1160L-K →	BN
	K		26	17	SO-1160S-K →	MC
	K		28	25	SO-1160L-K →	MC
 50 Pcs						
1172 	K		19	14	SO-1172-K →	BN
	K		19	14	SO-1172-K →	MB
	K		19	14	SO-1172-K →	MC
 50 Pcs						
1173 	16	42	19	14	SO-1173-16 →	BN
	16	42	19	14	SO-1173-16 →	CH
	16	42	19	14	SO-1173-16 →	MC
 50 Pcs						

Stefano Orlati Handles

Knobs

	Centre (mm)	Length (mm)	Height (mm)	Width (mm)	Item number	Finish
1179	K		28	22	SO-1179-K →	BN
	K		28	22	SO-1179-K →	MC
						
 50 Pcs						
1186	K	38	25	19	SO-1186-K →	BSAT
	K	38	25	19	SO-1186-K →	BSBN
						
 100 Pcs						
139	K		27	29	SO-139-K →	BN
	K		27	29	SO-139-K →	CH
	K		27	29	SO-139-K →	MC
						
 50 Pcs						
288	16	80	36	16	SO-288-16 →	BN
	16	80	36	16	SO-288-16 →	CH
	16	80	36	16	SO-288-16 →	FS
						
 40 Pcs						
					Complementary handles 1208 page → 8.16 Complementary handles 1186 page → 8.16	
					Complementary handle 288 page → 8.29	

Stefano Orlati Handles

Knobs

	Centre (mm)	Length (mm)	Height (mm)	Width (mm)	Item number	Finish
3318 	16	39	18	21	SO-3318-16 →	BN
	16	39	18	21	SO-3318-16 →	CH
	16	39	18	21	SO-3318-16 →	MC
 100 Pcs						
3320 	K		28	33	SO-3320-K →	BN
	K		28	33	SO-3320-K →	MC
 50 Pcs						
3321 	K		26	27	SO-3321-K →	BN
	K		26	27	SO-3321-K →	MC
 50 Pcs						

Stefano Orlati Handles

Knobs

	Centre (mm)	Length (mm)	Height (mm)	Width (mm)	Item number	Finish
3440	K	21	33	18	SO-3440-K →	BN
	K	21	33	18	SO-3440-K →	BSBN
Complementary handles 3440 page → 8.16						
						
 50 Pcs						
3590	K		24	15	SO-3590-K →	FS
						
 250 Pcs						
3801	K	33	25	33	SO-3801-K →	AB
	K	33	25	33	SO-3801-K →	BN
	K	33	25	33	SO-3801-K →	CH
	K	33	25	33	SO-3801-K →	P
	Complementary handles 8391 page → 8.17 Complementary handles 8392 page → 8.17					
 50 Pcs						

Stefano Orlati Handles

Knobs

	Centre (mm)	Length (mm)	Height (mm)	Width (mm)	Item number	Finish
6002   25 Pcs	32	50	31	36	SO-6002-32 →	AB
	32	50	31	36	SO-6002-32 →	MC
	Complementary handles 6002 page → 8.29					
8047   15 Pcs	K	38	31	38	SO-8047-K →	BN
	K	38	31	38	SO-8047-K →	MC
809   40 Pcs  Side Profile	16	28	18	12	SO-809-16 →	BN
	16	28	18	12	SO-809-16 →	CH
	16	28	18	12	SO-809-16 →	MC
	Complementary handle 809 page → 8.30					
8393   50 Pcs	K	64	32	22	SO-8393-K →	P
Complementary handles 8391 page --> 8.17 Complementary handles 8392 page --> 8.17						

Stefano Orlati Handles

Knobs

	Centre (mm)	Length (mm)	Height (mm)	Width (mm)	Item number	Finish
843 	K	35	22	35	SO-843-K →	AC
	16	54	22	54	SO-843-16 →	AC
	K	35	22	35	SO-843-K →	CH
	16	54	22	54	SO-843-16 →	CH
Complementary handle 843 page → 8.31						
	K	33	28	33	SO-8741-K →	AB
	K	33	28	33	SO-8741-K →	BN
	K	33	28	33	SO-8741-K →	CH
Complementary handles 8658 page → 8.17 Complementary handles 8407 page → 8.17						
929-1 	K	26	20	17	SO-929-1-K →	CH
	K	26	20	17	SO-929-1-K →	S
9909 	K	45		45	SO-9909-K →	AB
	K	45		45	SO-9909-K →	MB

50 Pcs

50 Pcs

50 Pcs

40 Pcs

Stefano Orlati Handles

Knobs

	Centre (mm)	Length (mm)	Height (mm)	Width (mm)	Item number	Finish
C10  25 Pcs	K	30	30	30	SO-C10-K →	WHC/P
Complementary handles C15 page → 8.18						
C14  25 Pcs	K	75	35	23	SO-C14-K →	WHC/P
Complementary handles C15 page → 8.18						
GL02  20 Pcs	K	35	28	35	SO-GL02-K →	CL/CH
Complementary handles C15 page → 8.18						
GL03  20 Pcs	K	35	32	35	SO-GL03-K →	CL/CH
Complementary handles C15 page → 8.18						

Stefano Orlati Handles

Knobs

	Centre (mm)	Length (mm)	Height (mm)	Width (mm)	Item number	Finish
MJ002   100 Pcs	K	52	18	9	SO-MJ002-K →	SN
MJ003   100 Pcs	K	30	25	30	SO-MJ003-K →	P
T905   50 Pcs	16	40	20	40	SO-T905K-16 →	AB
	16	40	20	40	SO-T905K-16 →	MC
Complementary handle T905 page → 8.35						

Stefano Orlati Handles

Knobs

	Centre (mm)	Length (mm)	Height (mm)	Diameter (mm)	Item number	Finish
947 		30	32	22	608.8K22.025.008	SC
	<p>50 Pcs Made of zinc</p>					
3515 			20	12	608.8K21.012.008	SC
			25	20	608.8K21.020.008	SC
			27	25	608.8K21.025.008	SC
	<p>50 Pcs Made of zinc</p>					
CV30 			30	30	608.8K20.030.007	PC
			30	30	608.8K20.030.008	SC
			30	30	608.8K20.030.003	BN
<p>50 Pcs Made of zinc</p>						

Stefano Orlati Handles

Knobs

	Centre (mm)	Length (mm)	Height (mm)	Width (mm)	Item number	Finish
9010	32	80		16	608.8Z00.000.403	SC



 80 Pcs

Made of zinc

Stefano Orlati Handles

Knobs



Length (mm)	Item number	Truss	Finish
12	611.8L35.245.012	Head Screw M4 x 12mm	ZP
16	611.8L35.245.016	Head Screw M4 x 16mm	ZP
20	611.8L35.245.020	Head Screw M4 x 20mm	ZP
22	611.8L35.245.022	Head Screw M4 x 22mm	ZP
25	611.8L35.245.025	Head Screw M4 x 25mm	ZP
32	611.8L35.245.032	Head Screw M4 x 32mm	ZP
35	611.8L35.245.035	Head Screw M4 x 35mm	ZP
38	611.8L35.245.038	Head Screw M4 x 38mm	ZP
42	611.8L35.245.042	Head Screw M4 x 42mm	ZP
45	611.8L35.245.045	Head Screw M4 x 45mm	ZP
50	611.8L35.245.050	Head Screw M4 x 50mm	ZP

 Up to 25mm / 1000 Pcs

 Over 25mm / 500 Pcs

